

Magma

9918 Via Pasar, San Diego, CA 92126, USA

Phone (800) 285-8990 US, (858) 530-2511 • Fax (858) 530-2733

www.magma.com

© 2007 Mission Technology Group, Incorporated, DBA Magma
This publication is protected by Federal Copyright Law, with all rights reserved. No part of this publication may be copied, photocopied, reproduced, stored in a retrieval system, translated, transmitted or transcribed, in any form or by any means manual, electric, electronic, electro-magnetic, mechanical, optical or otherwise, in whole or in part without prior written consent from Mission Technology Group, Inc..

Limitation of Liability
Information presented by Magma in this manual is believed to be accurate and reliable. However, Magma assumes no responsibility for its use. No license is granted by implication or otherwise to any rights of Magma.

Trademark References
Trademarks and registered trademarks are proprietary to their respective manufacturers.

Product specifications and prices are subject to change without notice.

09-09977-00-A1

Quick Installation Guide

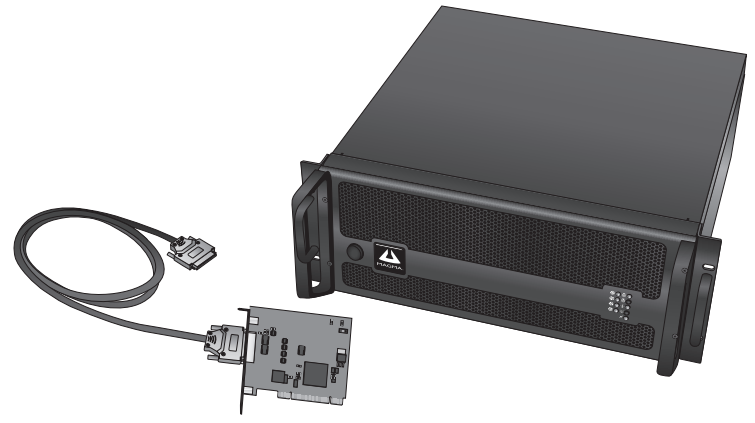

Magma PI3RR-RAS

Package Contents

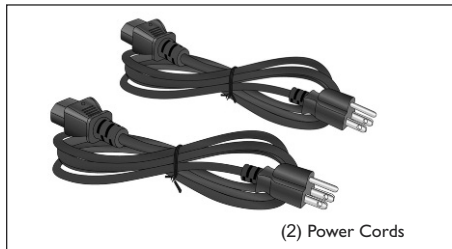
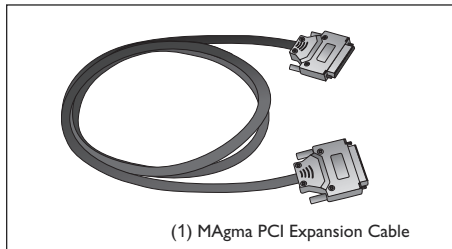
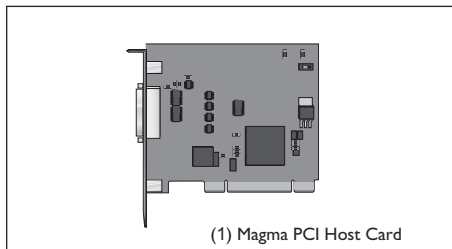
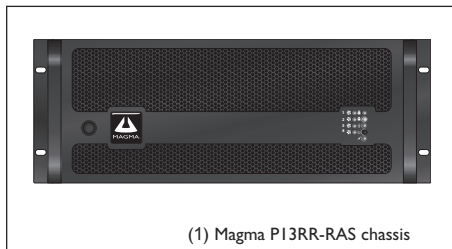

! IMPORTANT
Important safety information and other information on how to use Magma PI3RR-RAS are provided in the User Guide. This manual is available online for a download at www.magma.com/support/manuals.

1 Install PCI Host card and connect cables

Install the Magma PCI Host Card into an available PCI slot in your computer.

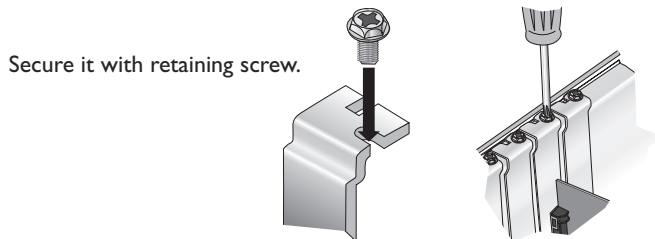
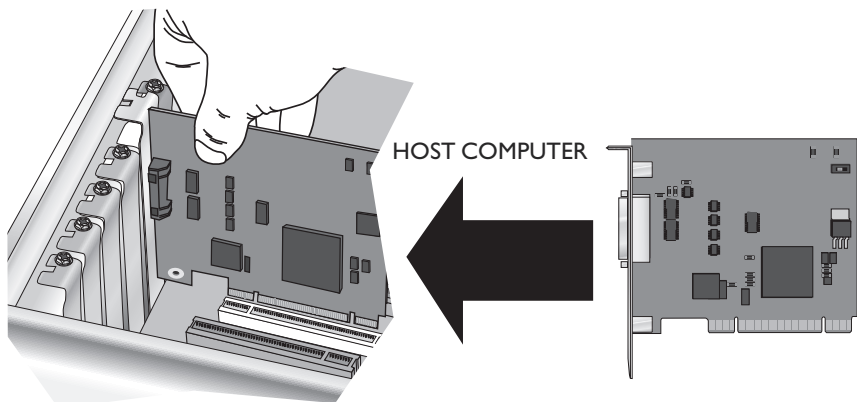

Connect one side of the PCI expansion cable to the host card.

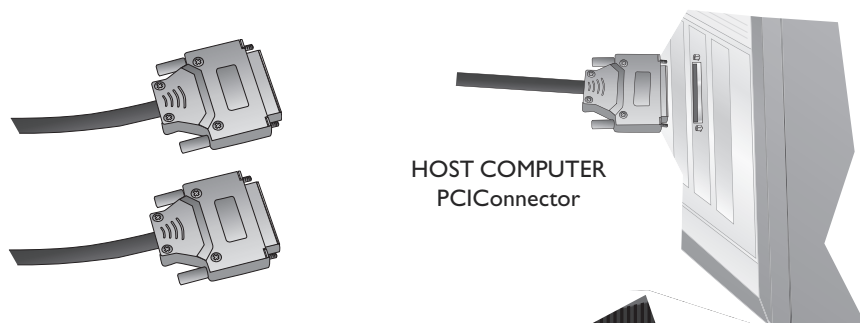

Connect the other side of the PCI expansion cable to the back of the PI3RR-RAS chassis. Ensure that the system's redundant Power Supply Units are switched off and connect the chassis power cords.

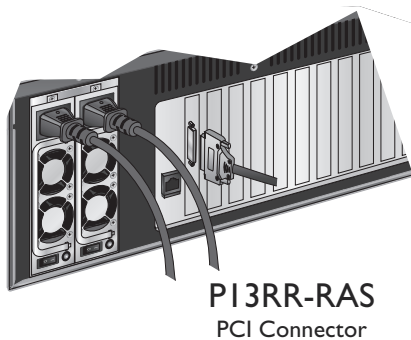

2 Open Enclosure

Remove the 2 thumbscrews that retain the top cover of the expansion chassis.

(2 locations)

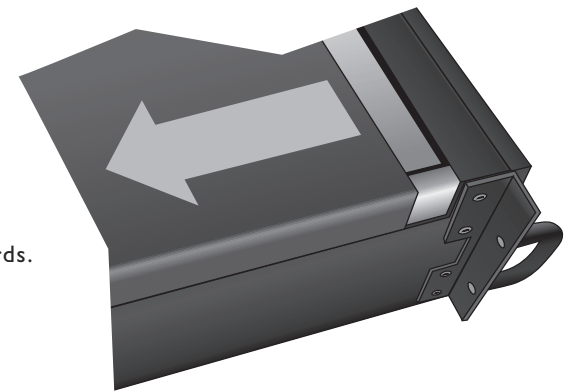
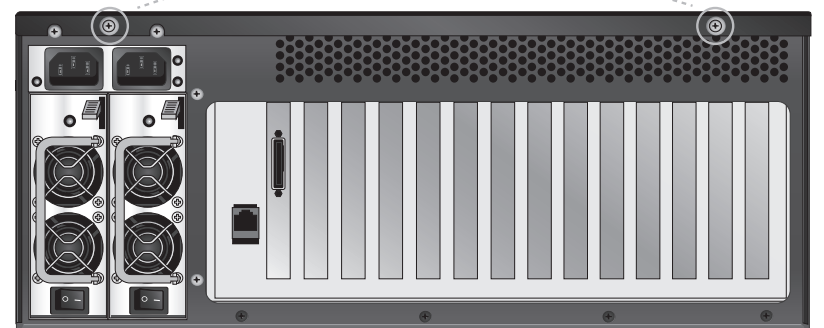

3 Install PCI cards

Remove PCI filler bracket for the expansion slot you wish to use in the chassis. Install peripheral PCI card into the slot connector and secure with retaining screw.

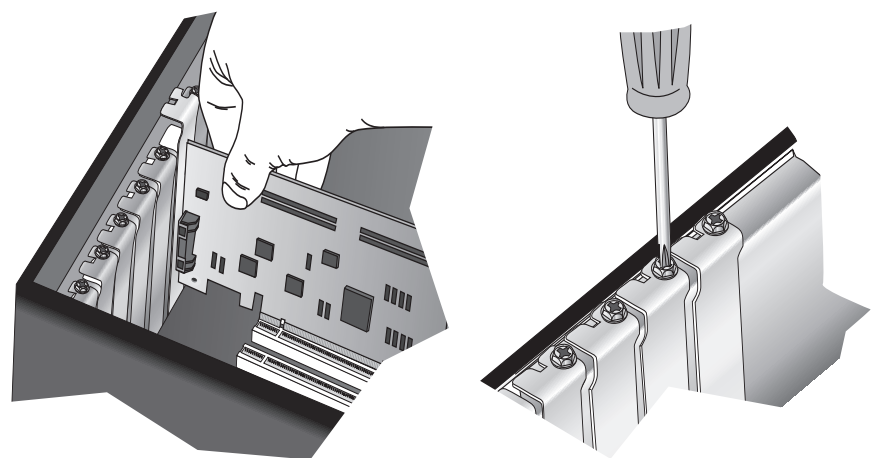

Repeat the process for all other PCI peripherals you wish to install in the chassis.

4 Power on PI3RR-RAS

Each of the redundant power supplies has its own power switch and led. Turn on each of the individual power switches on the rear of the chassis, verify that the green LED above the power switch is on, then push the main power button on the front of the chassis.

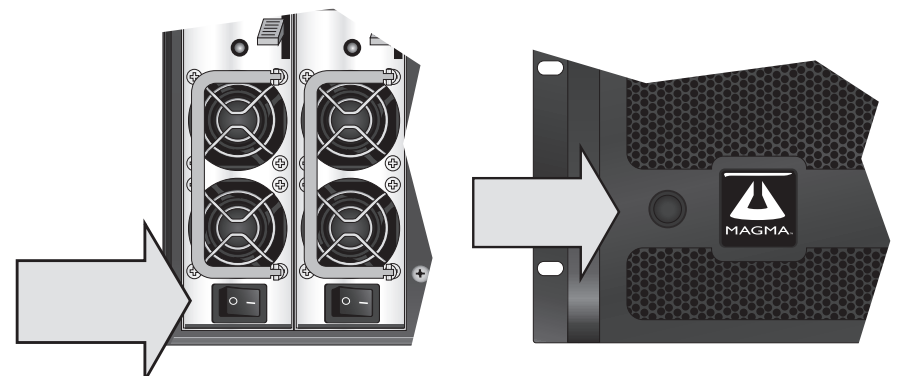

! IMPORTANT: You must apply power to the PI3RR-RAS expansion chassis before you power up the host computer.

5 Power on Computer

There are two methods to powering up the PI3RR-RAS chassis. The first is to apply power by actuating the power switch on the PI3RR-RAS before applying power to the host. The second method is to have the host power up operation provide the power up to the PI3RR-RAS via the Host Card and cable attached to the chassis; this requires that the redundant power supplies be turned on, but the main power switch on the chassis be left alone. Either of these methods will allow the host BIOS to identify and assign resources to the chassis properly.



6 How to Verify Installation

To verify a successful installation of the PI3RR-RAS on Windows XP or 2000, find the 'MyComputer' icon > Right-click and select 'Manage' > Highlight 'DeviceManager' > Click on the View Menu and select View Devices by Connection. Open ACPI (BIOS) > Open PCI Bus > Click the '+' sign several times until you reach the PCI Standard PCI to PCI Bridge.

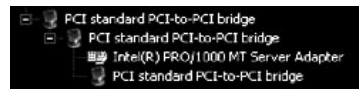
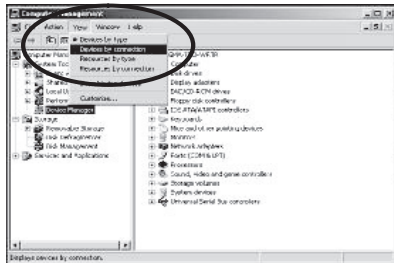

1. Windows When installed correctly, you will see three "PCI to PCI Bridges" below your system's PCI Controller. If, however, the installation was unsuccessful, you may not see the PCI to PCI Bridge, or it will have a small yellow in front of it. Refer to manual for troubleshooting help.

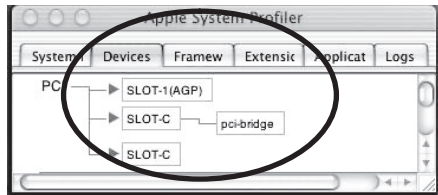

Mac OS 10.2.x

Card	Type	Bus	Slot
pci-bridge	pci	PCI	SLOT-2
pci-bridge	pci	PCI	2x4
ATTO ExpressPCI UL3S	scsi-2	PCI	8x4
ATTO ExpressPCI UL3S	scsi-2	PCI	8x4
pci-bridge	pci	PCI	8xc

Mac OS 10.3.x & 10.4.x

2. MAC OS X: When using Mac OS X no additional software or drivers are needed. As long as you are using Mac OS X Version 10.2.2 or newer, the operating system should automatically recognize the MAGMA expansion chassis. To see open slots in PI3RR-RAS, click on: About This Mac > More Info > Devices PCI Cards you install in the expansion chassis will appear behind the pci-bridge device.

7 Front and Rear Panel Indicators

LEDs on the front panel monitor internal temperature and show status of fans and power supplies. All LED's should be green at all times. An orange LED means a fault of the corresponding item. The locator LED and locator switches on the front and back panel locates the chassis in a rack installation. Push the switch on either end of the chassis and the LED will blink on both front and back. Pressing either switch again, on either side of the chassis, will turn the LED off. See manual for more information and a description of internal indicators.

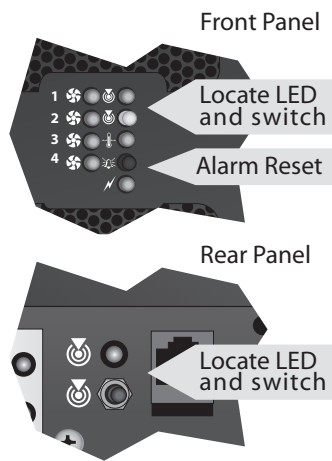

Shutdown Procedure

It is recommended that you first shut down and wait for the host to power off before powering down the PI3RR-RAS. The PI3RR-RAS will automatically power down if the host is used to power up the PI3RR-RAS as described in the Power on Computer section.

Troubleshooting

Problem: Computer locks-up during restart while the Expansion Chassis is connected (with 3rd Party PCI cards installed).

Trouble Shooting Measures:

1. Disable any device that is not being utilized in the BIOS and Device Manager.
2. Try Updating the BIOS.
3. Configure BIOS to optimal setting, if it's available.
4. Try using different Motherboard.
5. Try a different available PCI slot.
6. Try different PC.
7. If 3rd Party PCI card causes system to lock-up try a different model or brand of PCI card.
8. Remove the problem Third Party PCI card and use simple PCI card and see if problem persists.
9. Try a different Magma Host Card
10. Try a different Expansion Chassis.
11. Remove "Third Party PCI card from the Chassis and switch it with other Third Party PCI card.

Problem: I see an exclamation point in front of my PCI card in Windows Device Manager or my PCI card has a problem.

Solution: Windows XP users should log on to:

www.magma.com and select Support > Drivers & Utilities to check if a Magma driver has been issued for their ExpressBox chassis. Windows Vista users, ensure your PCI card is supported under Vista. Check with the card manufacturer to see if drivers are required. If required, install drivers following manufacturer's instructions.

IMPORTANT: If installing video card(s) in the PI3RR-RAS chassis, be sure to connect any external DC power required by the particular card for it to operate properly.

If trouble persists, contact Magma Technical Support.

Technical Help

Contact Technical Support by phone at (858) 530-2511. Support is available Monday through Friday, 8:00 AM to 5:00 PM Pacific Time.

Web: www.magma.com/support



Electrostatic Discharge (ESD) Warning

Electrostatic Discharge (ESD) is the enemy of semiconductor devices. You should always take precautions to eliminate any electrostatic charge from your body and clothing before touching any semiconductor device or card by using an electrostatic wrist strap and/or rubber mat.

FCC Statement

NOTE: This equipment has been tested and found to comply with the limits for a Class A digital device, pursuant to part 15 of the FCC Rules. These limits are designed to provide reasonable protection against harmful interference when the equipment is operated in a commercial environment. This equipment generates, uses, and can radiate radio frequency energy and, if not installed and used in accordance with the instruction manual, may cause harmful interference to radio communications. Operation of this equipment in a residential area is likely to cause harmful interference in which case the user will be required to correct the interference at his own expense.

This device complies with Part 15 of the FCC Rules. Operation is subject to the following two conditions: (1) this device may not cause harmful interference, and (2) this device must accept any interference received including interference that may cause undesired operation.

Changes or modifications not expressly approved by the party responsible for compliance could void the user's authority to operate the equipment.

Industry Canada

This Class A digital apparatus complies with Canadian ICES-003.
Cet appareil numérique de la classe A est conforme à la norme NMB-003 du Canada

CE

The product(s) described in this manual complies with all applicable European Union (CE) directives. Magma will not retest or recertify systems or components that have been reconfigured by customers.

Warranty and Repair Policy For Magma PI3RR-RAS

30 DAY MONEY BACK GUARANTEE. Your satisfaction is extremely important to us, and your feedback helps us improve our products and services. If for any reason you are not 100% satisfied with your Magma product, contact the Magma Sales Department, and return your product postmarked within 30 days of the invoice date for a full refund or exchange, excluding shipping and handling charges, and any international duties. After 30 days, product may be returned only for repair or replacement, as provided below under Product Warranty. In order to receive full-credit for the price of the product, all returned products must be returned 100% complete and in new condition, including all components and other accessories provided by the manufacturer, with all original manuals and documentation, in the original container and packing materials. The value of any missing components or other accessories will be deducted from the refund. Refunds will be made with the same method of payment as the original order when purchased direct from Magma only. Credit card refunds may be made only to the same card used for the original purchase. If a check was used, a refund may take up to 45 days.

PRODUCT WARRANTY. Magma warrants this product to be free from defects in material or workmanship, so long as used in accordance with its applicable documentation, for a period of one (1) year from the date of shipment to you (the "Warranty Period"). Should you need to return this product for any reason, you must first obtain a Returned Material Authorization (RMA) number by calling 858.530.2511, or completing a Technical Support Request form on our website at www.magma.com. Your RMA number will be valid for only 30 days after it was issued to you. If you do not return your product within 30 days, you must obtain another RMA number. You are responsible for packaging the product, including its components and other accessories, its original manual or other printed material, all in a well-padded, sturdy box, with adequate protection for shipment, and you must pay the shipping, insurance, excise or other taxes and similar costs to get it to us. We strongly recommend you fully insure it, and also that you use a shipping method which provides you a tracking number you should retain for proof that we received it. The RMA number must appear on both the inside and outside of the box. Boxes without RMA numbers appearing on the outside will not be accepted, and will be returned.

Return it to: Magma Returns Department
ATTN: RMA # _____
9918 Via Pasar
San Diego, CA 92126 USA

Products received with physical defects must be reported to a Magma Technical Support Specialist immediately upon receipt, even if functioning properly despite the defect. It could impact upon future Product Warranty options if not reported immediately. If returned during the Warranty Period, we will repair or replace your product, in our sole discretion. We will return your repaired or replaced product to you within 7 business days of receipt at our dock, freight prepaid via ground service, unless a Technical Support Specialist informs you of an extended date. If your product requires repair due to an item not covered by this warranty, or is outside its Warranty Period, you may instruct us to repair it at our quoted price, if it can be repaired, or we will return it to you without repair.

This warranty does not cover: (a) damage or loss during transport; (b) damages as a result of natural elements such as rain, snow, fire, or other calamities; (c) damage from misuse, abuse, or accidents; (d) repainting, refinishing, or refurbishing the product; (e) labor required to diagnose the problem if such problem is a result of any of the foregoing conditions; or (f) products that have previously owned, or purchased secondhand. This warranty shall be void if any product: (1) is altered, repaired, or any attempt at the same has been made by any party not authorized by us; (2) has had the serial number or any labels removed, altered, or tampered with; or (3) has not been operated within conditions required by the specifications.

You must exercise your warranty claim within one (1) year from the date the product was originally shipped to you. If we issue you an RMA number, it does not mean we have determined that your product is still under warranty.

THIS WARRANTY IS IN LIEU OF ALL OTHER WARRANTIES, EXPRESS OR IMPLIED, AND WE EXPRESSLY DISCLAIM ALL OTHER WARRANTIES TO THE MAXIMUM EXTENT ALLOWED BY LAW, INCLUDING THE IMPLIED WARRANTIES OF MERCHANTABILITY, FITNESS FOR ANY PARTICULAR PURPOSE AND NON-INFRINGEMENT. Our sole liability, and your sole remedy, in contract, tort, or otherwise, shall be limited to repair or replacement of defective product. We will not be liable for indirect, direct, special, punitive, or consequential damages of any kind, including loss of use, loss or damage to other equipment, or lost profits arising out of or in connection with use of the product, even if we have been advised of the possibility of such damages. In some jurisdictions, the foregoing disclaimers or limitations on damages are prohibited or limited by law, so they may not apply to you.

DOA (DEAD ON ARRIVAL) PRODUCTS. Magma product is considered DOA if it displays symptoms of hardware failure within 30 days of shipment. If you believe that your product is DOA, please contact Magma Technical Support within 30 days of shipment. A Magma Technical Support Specialist may offer the following options:

1. Complete Replacement: The same product that you ordered will be shipped to you at Magma's expense.
 2. Component Replacement: If it can be determined that a particular component is causing the failure, (e.g. power supply) a replacement component will be shipped to you at Magma's expense.
- In both instances mentioned above, a Magma Technical Support Specialist may choose to issue a 'Call Tag' to retrieve the defective product at Magma's expense. It is your responsibility to ensure the defective product is properly packaged for shipment and ready at the time of the scheduled Call Tag pick-up. If the reported product problem is deemed by a Magma Technical Support Specialist to be either (1) NOT DOA, or (2) DOA more than 30 calendar days after shipment, the standard Product Warranty will apply. Magma reserves the right to test returned DOA product. If the condition of the product is misrepresented, Magma may impose a \$75.00 handling fee.

PRODUCTS DAMAGED IN SHIPPING. Magma ensures that all Products will be suitably packed, marked and shipped in accordance with common carrier and other applicable requirements. It is your responsibility to handle damage caused in shipping. Therefore, it is highly recommended that you do not sign the delivery receipt for your shipment until you have determined that it is free of shipping damage. If you determine that the Product has been damaged in shipping, you are responsible for filing a damage claim with the freight company.

ADVANCED REPLACEMENT SERVICE. Magma offers an Advanced Replacement Service primarily intended to address severe problems encountered in a system within the first 60 days after shipment. Under the terms of this service, Magma will expedite the shipment of a replacement product prior to receiving the defective product. Advanced replacements are available by providing a VISA, MasterCard or American Express card which will be charged the list price of the replacement product and associated shipping costs. The cost for this service is ranges from \$25 to \$100 plus a 25% restocking fee. Credit for the purchase price of the original product will be issued 7-10 business days after receipt of the original product. The original product must be returned to Magma with all parts and components that were shipped with it, in undamaged condition. You are responsible for missing components and/or systems or components that are found to be physically damaged upon return. Advanced Replacement Service is not offered for the following products:

1. Out of Warranty products: If your product is out of warranty and requires repair, please refer to the Out of Warranty Repair Service detailed below.
2. OEM branded products: If your product is manufactured by Magma, but carries another brand name, please contact the company whose brand name appears on the product, or the third-party company who sold you the product for information regarding their advanced replacement policies.

NON-RETURNED ADVANCED REPLACEMENTS. Defective product cannot be returned for credit after 90 days following arrival of your Advanced Replacement.

EXPEDITED REPAIR OPTIONS. Although Magma does not offer an Expedited Repair Program, there are methods to expedite the receipt of your replaced or repaired Product:

1. Expedited Shipping: You may request priority shipping and must bear the extra costs of priority shipping by providing a VISA, MasterCard or American Express card number to a Technical Support Specialist when the RMA number is requested.
2. Advanced Replacement: The fee-based Advanced Replacement Service described above is the quickest method to replace defective product.

OUT OF WARRANTY REPAIR SERVICE. Magma will attempt to repair out-of-warranty defects at an additional charge. You will be charged a minimum evaluation fee of \$150 (includes 1 hour of test and repair time, additional test time will be charged at \$75 per hour). You are responsible for all shipping charges. If repairs are authorized, the evaluation fee will be deducted from the cost to repair the product. If repairs are not authorized, you will be responsible for paying the evaluation fee. Once evaluation has been completed, a Technical Support Specialist will contact you with any options you may have and to request your authorization of the repair work before the repair is performed. It is highly recommended that you provide a day-time telephone number and email address to ensure that the Technical Support Specialist can reach you to discuss your repair options. Please call for an RMA number before returning the product. You must provide your authorization or decline the repair cost within 10 days of notification. If you fail to respond within 30 days after you were informed of the repair charge, Magma will close the RMA automatically and return the product to you, as is. Magma warrants an out-of-warranty repaired product for a period of 90 days from the date of repair.

EXTENDED WARRANTY. Magma will extend the terms of our standard 1-year warranty for an additional 1 year if you opt to purchase an extended warranty at the time of the purchase of the particular Magma product to which it relates. An extended warranty cannot be purchased at a later time. If you opt for the extended warranty plan, the total warranty period on your Magma product will be 2 years from the date of shipment.

For questions, contact Magma at (858) 530-2511 or visit us on the web at www.magma.com.